

FEATURES:

- ✓ Architectural linear luminaire with Direct or Direct/Indirect distribution.
- ✓ Light source: 11" LED Modular Board.
- ✓ Dark Optic provides superior lighting distribution with precise low glare illumination.
- ✓ Offered with Regular 50°/10UGR, Flood 80°/15UGR or Asymmetric beam angle.
- ✓ Available for row mounted installations in various lengths.
- ✓ Suitable for Surface, Suspended, Recessed and Wall Mount installations.
- ✓ Extruded aluminum body comes with White, Black or Grey finish.
- ✓ Also available with custom color options.
- ✓ LED's are rated for 60,000hrs. L80 with +90CRI.
- ✓ Has a proven record in office, commercial and retail installations.
- ✓ Custom modifications are available.
- ✓ ED luminaires are certified to CSA and UL Standards.

reinventlight

SPECIFICATION:

ED VECTOR+ - - - - - - - - - - - -

Enter the Product Code into the boxes above.

- | | | | | | |
|---|---|--|---|---|--|
| TYPE
<input type="checkbox"/> DO - Dark Optic | SIZE
<input type="text"/> Feet*
<small>* 1 Foot increments only.</small> | SOURCE
<input type="checkbox"/> 5W/Ft LED
<input type="checkbox"/> 7W/Ft LED
<input type="checkbox"/> 10W/Ft LED | RADIANCE
<input type="checkbox"/> DD - Direct (100%Down)
<input type="checkbox"/> UD - Uneven (70%Down/30%Up)**
<small>*Light distribution.
**Available for Surface/Wall Mount configurations only.</small> | VOLTAGE
<input type="checkbox"/> 120V
<input type="checkbox"/> 277V
<input type="checkbox"/> 347V*
<small>*Not available for all configurations.</small> | DRIVER
<input type="checkbox"/> ST - Standard (Non-Dimming)
<input type="checkbox"/> DL - 0-10V Dimming (1%)
<input type="checkbox"/> DA - DALI
<input type="checkbox"/> BT - Bluetooth
<input type="checkbox"/> <input type="text"/> *
<input type="checkbox"/> EC - Emergency Circuit
<input type="checkbox"/> EM - Emergency**
<small>*Please specify dimming method.
**Battery Pack per 4 foot section.</small> |
|---|---|--|---|---|--|

- | | | | | | |
|---|---|---|---|---|--|
| MOUNTING
<input type="checkbox"/> S4 - Suspension 4 Feet
<input type="checkbox"/> S6 - Suspension 6 Feet
<input type="checkbox"/> S <input type="text"/> Feet*
<input type="checkbox"/> WM - Wall Mount
<input type="checkbox"/> WF - Wall Flush
<input type="checkbox"/> SF - Surface Mount
<input type="checkbox"/> RT - Recessed Trimless
<small>*Please specify required length.</small> | REFLECTOR
Square:
<input type="checkbox"/> S/WH - White
<input type="checkbox"/> S/BK - Black
<input type="checkbox"/> S/SL - Silver
<input type="checkbox"/> S/GD - Gold
<input type="checkbox"/> S/RD - Red
<input type="checkbox"/> S/GM - Gunmetal
Round:
<input type="checkbox"/> R/WH - White
<input type="checkbox"/> R/BK - Black
<input type="checkbox"/> R/SL - Silver
<input type="checkbox"/> R/GD - Gold
<input type="checkbox"/> R/RD - Red
<input type="checkbox"/> R/GM - Gunmetal | LENS
<input type="checkbox"/> RB - Regular 50°
<input type="checkbox"/> FB - Flood 80°
<input type="checkbox"/> AB - Asymmetric | FINISH
<input type="checkbox"/> WH - White
<input type="checkbox"/> BK - Black
<input type="checkbox"/> GR - Grey
<input type="checkbox"/> CF - Custom <input type="text"/> RAL# | CCT
<input type="checkbox"/> 30K/90CRI - 3000Kelvin
<input type="checkbox"/> 35K/90CRI - 3500Kelvin
<input type="checkbox"/> 40K/90CRI - 4000Kelvin | OPTIONS
<input type="checkbox"/> No Options*
<input type="checkbox"/> DC - Dual Circuit**
<small>*Leave empty.
**Down/Up control separately.</small> |
|---|---|---|---|---|--|

LUMEN OUTPUT W/Ft:

Watts	30K	35K	40K
5W	610 lm	625 lm	640 lm
7W	855 lm	875 lm	895 lm
10W	1225lm	1250 lm	1275 lm

Project:

Type:

SIZE:

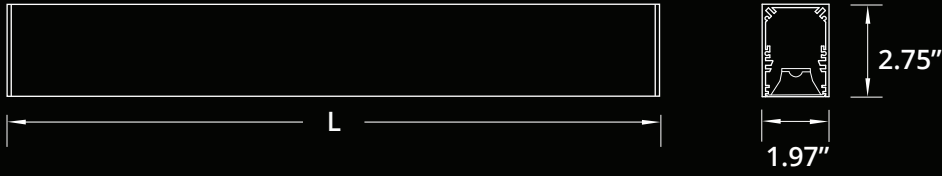

Size	L (LENGTH)	LED Strips
1 Feet	11.32 Inch	1 x 11"
2 Feet	22.30 Inch	2 x 11"
3 Feet	33.29 Inch	3 x 11"
4 Feet	48.00 Inch	4 x 11"
5 Feet	60.00 Inch	5 x 11"
6 Feet	72.00 Inch	6 x 11"
7 Feet	84.00 Inch	7 x 11"
8 Feet	96.00 Inch	8 x 11"

RADIANCE:

DIRECT DISTRIBUTION



UNEVEN DISTRIBUTION



MOUNTING:

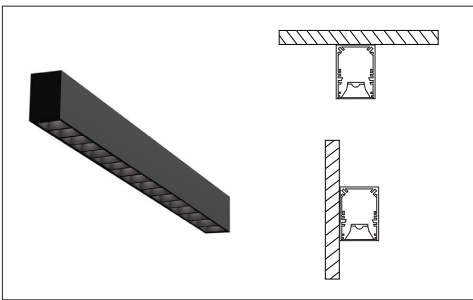

SURFACE MOUNT, WALL FLUSH

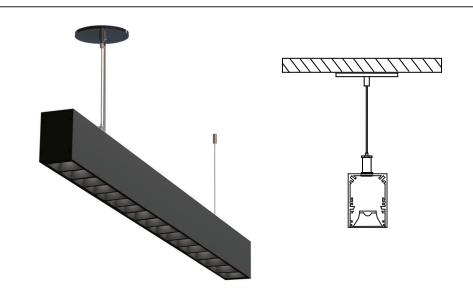

SUSPENDED

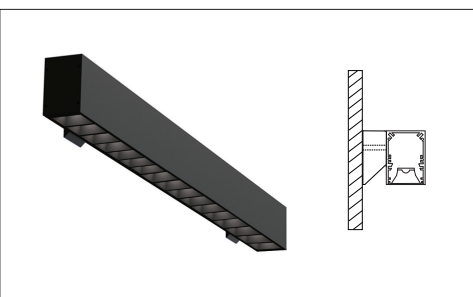

WALL MOUNT

REFLECTORS:

SQUARE:



WHITE



SILVER



BLACK

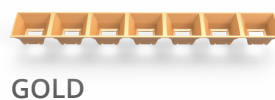

GOLD

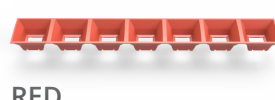

RED



GUNMETAL

ROUND:

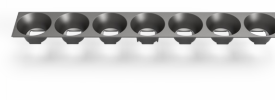
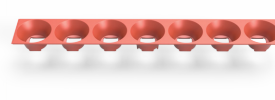
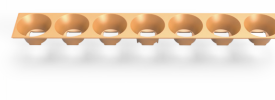

BEAM:

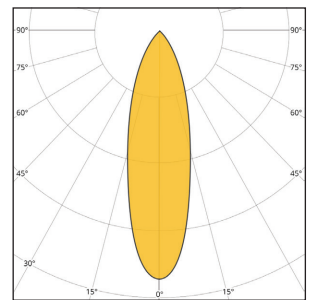

REGULAR BEAM

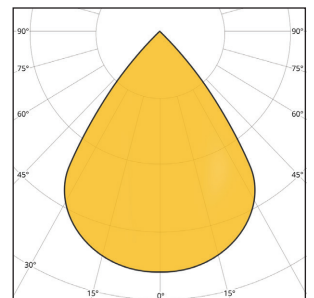

FLOOD BEAM

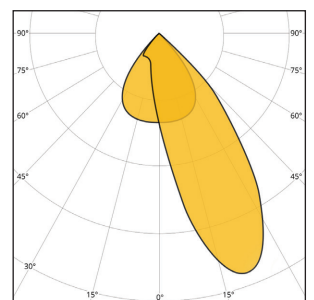

ASYMMETRIC BEAM