



ACOUSTIC SEATING PRODUCT INDEX

ZONE

STAY IN YOUR COMFORT ZONE



NEST

NEST IN COMFORT & CALM

VIBE

COLOURFUL VIBES & VIBRANT SPACES



ZONE

ACOUSTIC POD + POUF



FIND YOUR COLOURFUL COMFORT ZONE

Zone Acoustic Pod is ideal for lobbies and lounges, libraries, airports, waiting rooms and offices.

The pouf adds extra comfort and doubles as a side table.

Perfect for any interior where the reverberation of sound is an issue and comfort & privacy are a priority.



SOUND ABSORBANT



2 YEAR GUARANTEE



FIRE RESISTANT



ANTI-MICROBIAL



VERSATILE



EASY TO CLEAN

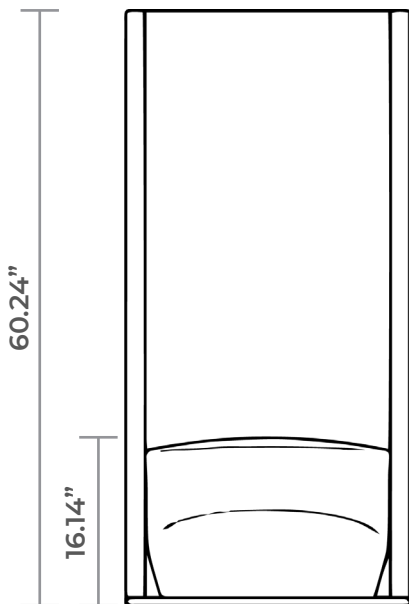

POD DIMENSIONS

Width	28.74"
Depth	27.17"
Height	60.24"
Seat Height	16.14"

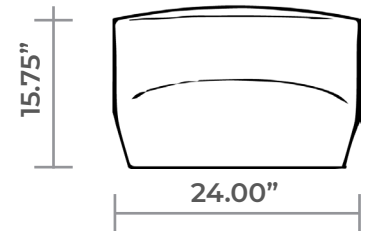
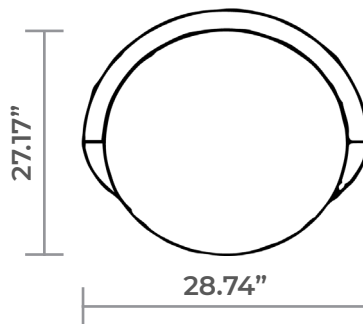

POUF DIMENSIONS

Width	24.00"
Depth	22.83"
Height	15.75"



ZONE

ACOUSTIC POD + POUF



Each ZONE Acoustic Pod is upholstered in two types of acoustic fabric that is not only soft to the touch but easy to clean.

In fact, most stains can be removed with just water!

With a flexible polyurethane seat and rubber coated wood back, the ZONE Acoustic Pod is the ideal choice for comfort, privacy and sound management.

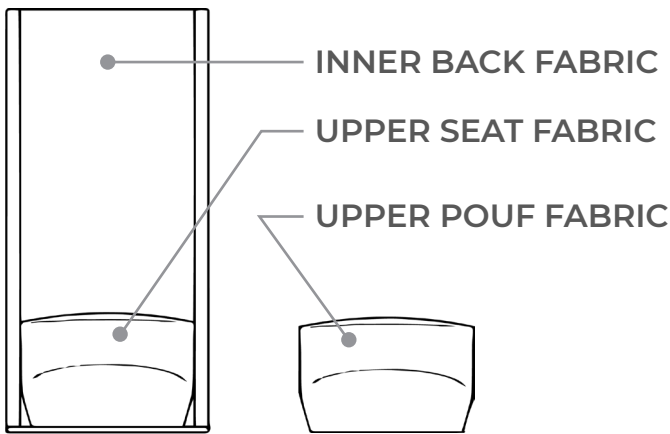

SOFTY FABRIC

*Standard for all inner & upper portions of pod & pouf.

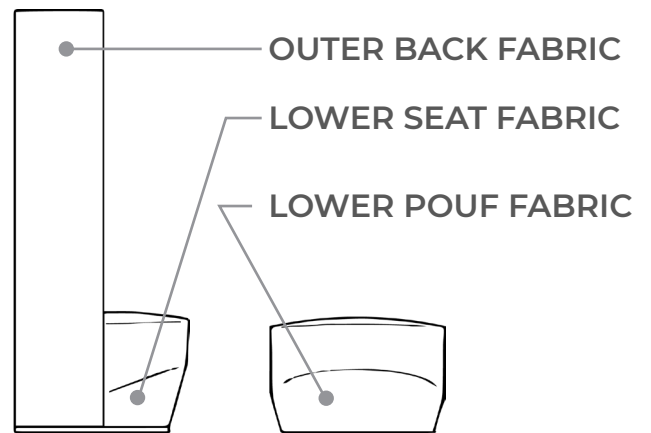

CHOICE OF 18 COLOURS FOR THE ACOUSTIC POD BACK

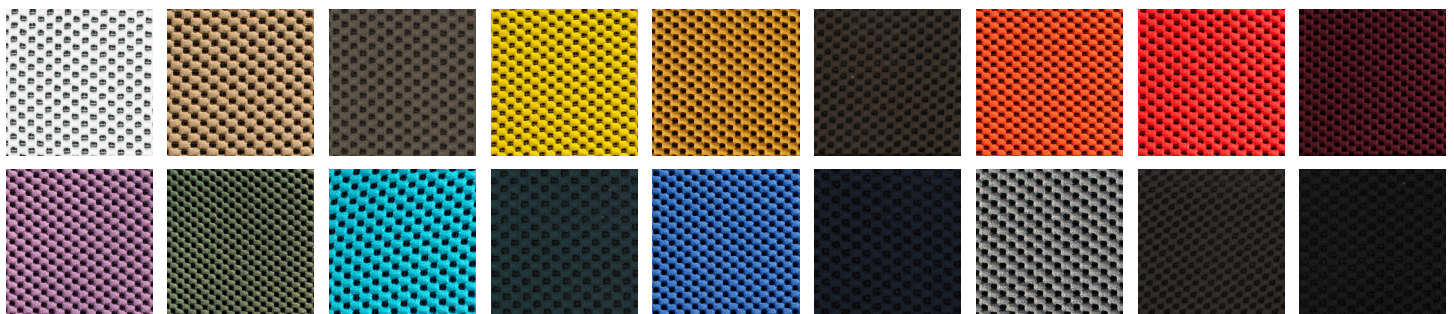

SPOCK FABRIC



ZONE

ACOUSTIC POD + POUF



SNOW ZONE

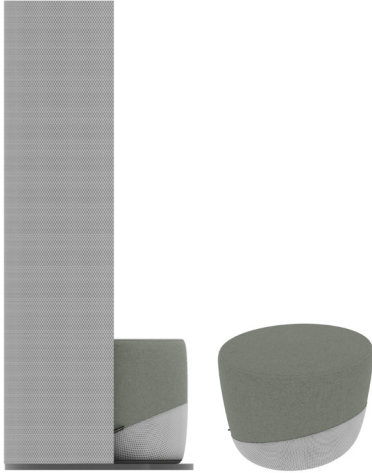

DUNE ZONE



WOOD ZONE



BUMBLEBEE ZONE



HONEY ZONE



COFFEE ZONE



CORAL ORANGE ZONE

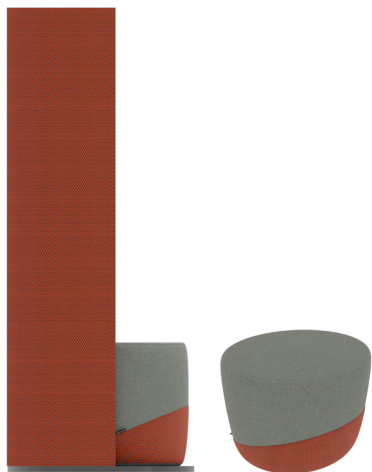

CANDY RED ZONE

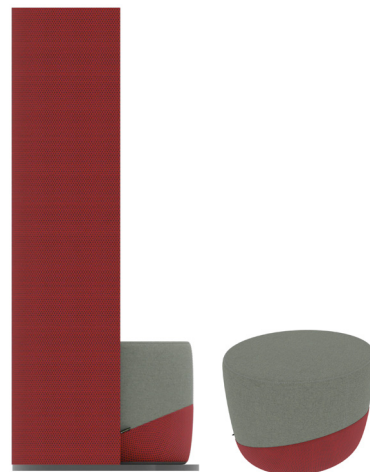

BORDEAUX ZONE



ZONE

ACOUSTIC POD + POUF



VIOLET ZONE



JUNIPER ZONE



TURQUOISE ZONE



RIVER GREEN ZONE



ROYAL BLUE ZONE



DENIM ZONE



SILVER ZONE



GRAPHITE ZONE



BLACK ZONE



NEST

ACOUSTIC ARMCHAIR + POUF

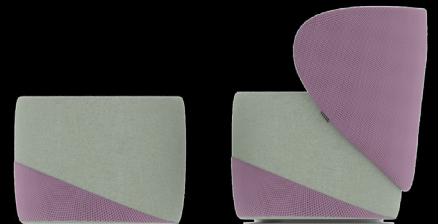

FEEL COMFORTABLY NESTED

Nest Acoustic Armchair is ideal for huddle rooms, lobbies and lounges, hotels, schools and libraries, home cinemas and family rooms.

Perfect for any interior where sound reverberation is an issue and comfort & style are a priority.

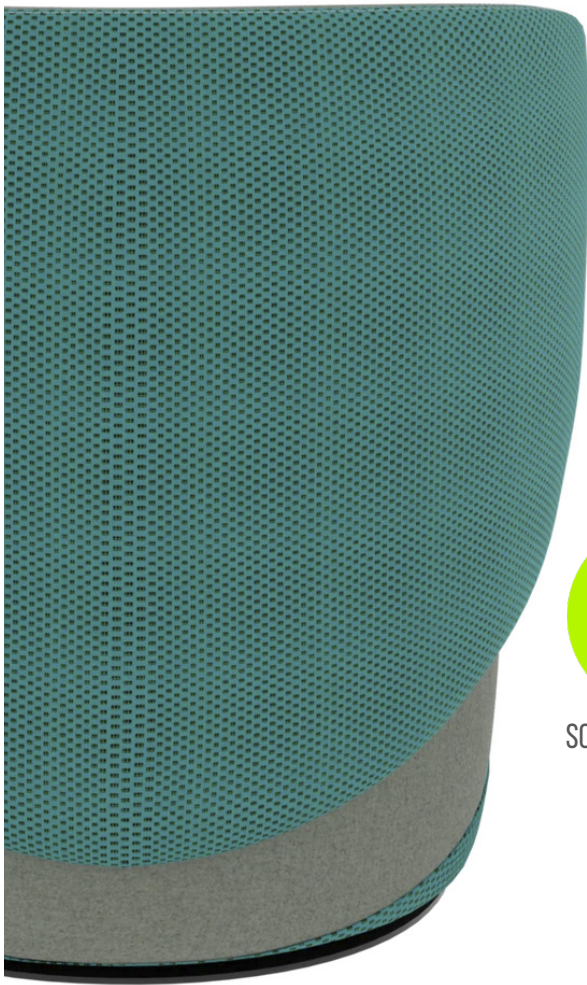

SOUND ABSORBANT



2 YEAR GUARANTEE



FIRE RESISTANT

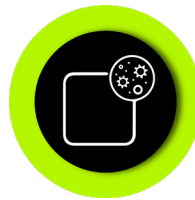

ANTI-MICROBIAL



VERSATILE



EASY TO CLEAN

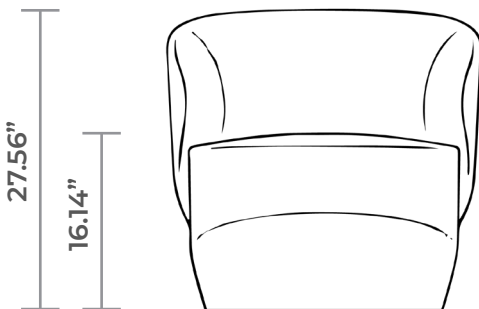

ARMCHAIR DIMENSIONS

Width	28.74"
Depth	27.17"
Height	27.56"
Seat Height	16.14"

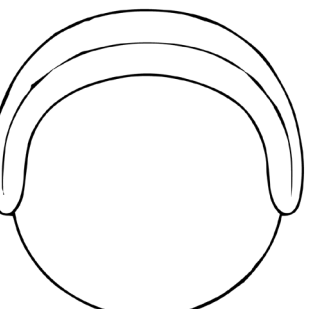
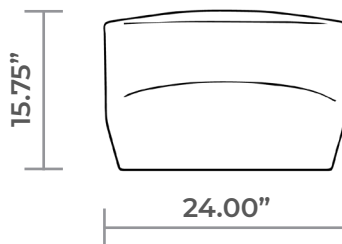
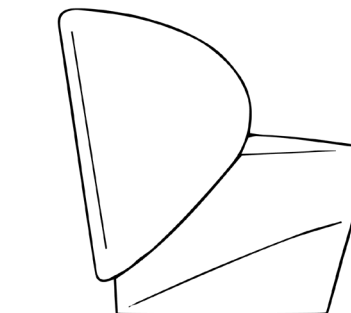

POUF DIMENSIONS

Width	24.00"
Depth	22.83"
Height	15.75"



NEST

ACOUSTIC ARMCHAIR + POUF



Each NEST Acoustic Armchair is upholstered in two types of acoustic fabric that is not only soft to the touch but easy to clean.

In fact, most stains can be removed with just water!

NEST Armchair's internal structure is composed of a metal frame molded in cold polyurethane foam. Maximum seating comfort is achieved with the addition of flexible polyurethane seat and back padding. A 360° black swivel base completes the design.



SOFTY FABRIC

*Standard for all inner & upper portions of armchair & pouf.

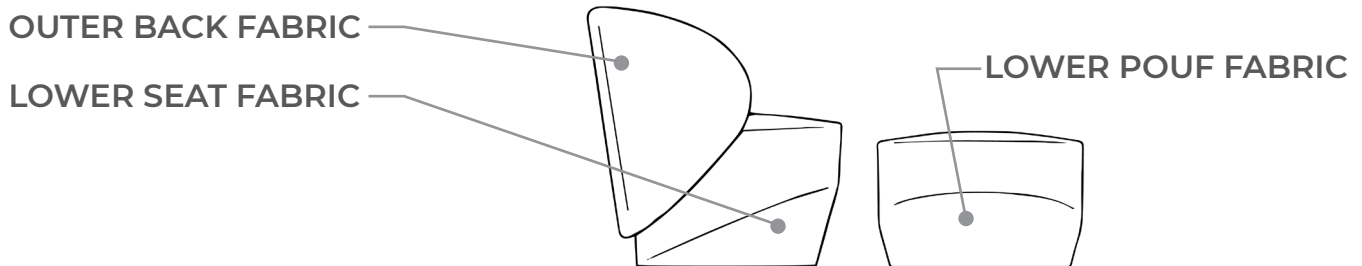
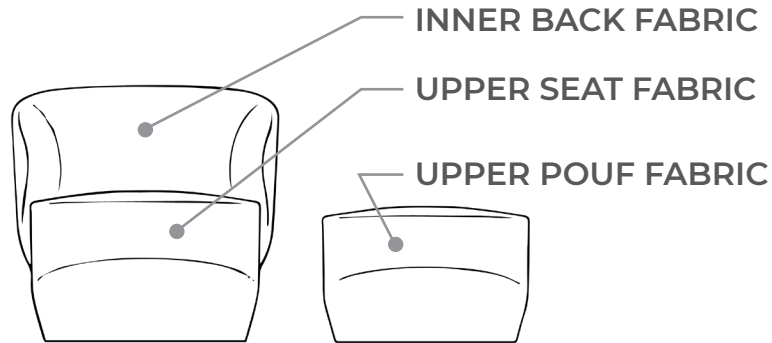

CHOICE OF 18 COLOURS FOR THE ARMCHAIR BACK

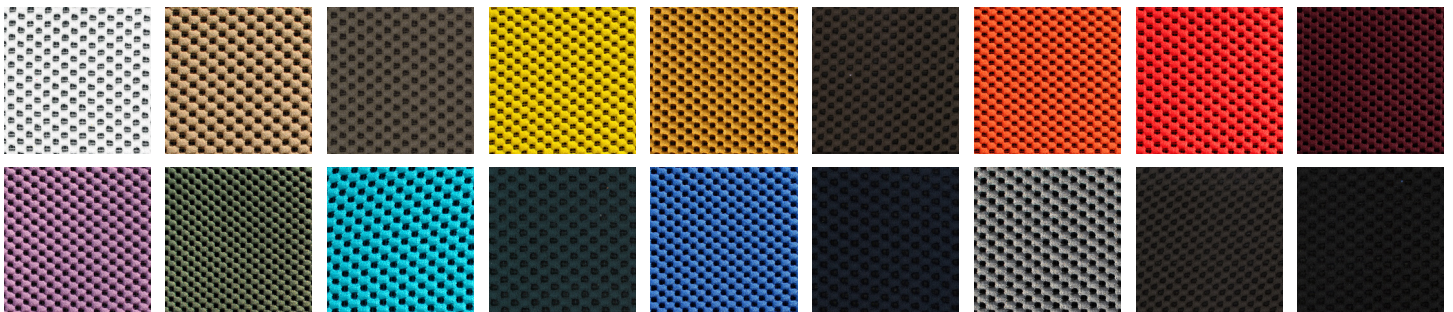

SPOCK FABRIC



NEST

ACOUSTIC ARMCHAIR + POUF

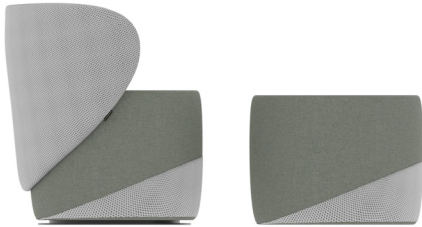

SNOW **NEST**

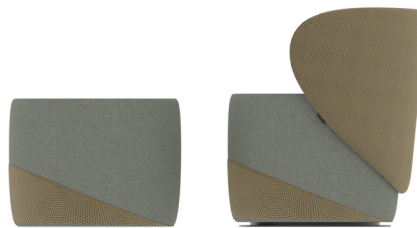

DUNE **NEST**

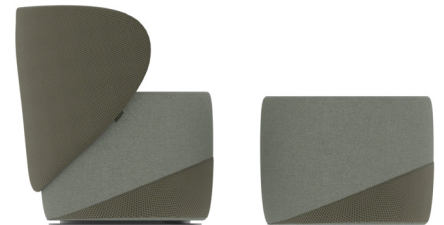

WOOD **NEST**



BUMBLEBEE **NEST**



HONEY **NEST**

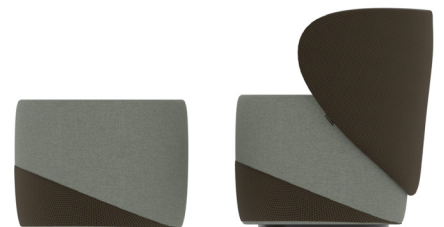

COFFEE **NEST**

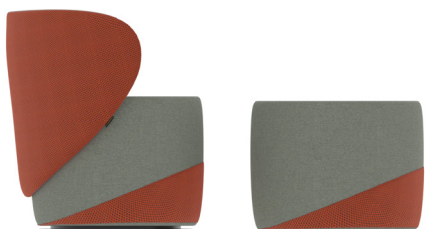

CORAL ORANGE
NEST

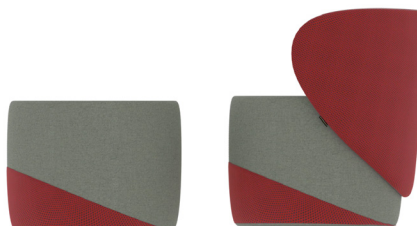

CANDY RED **NEST**



BOURDEAUX **NEST**



NEST

ACOUSTIC ARMCHAIR + POUF



VIOLET NEST

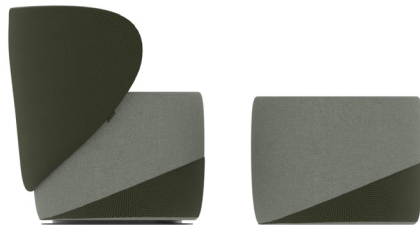

JUNIPER NEST

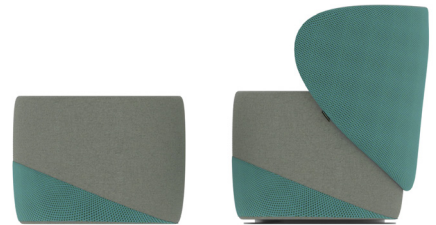

TURQUOISE NEST

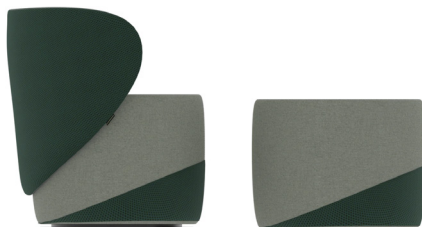

RIVER GREEN NEST



ROYAL BLUE NEST



DENIM NEST

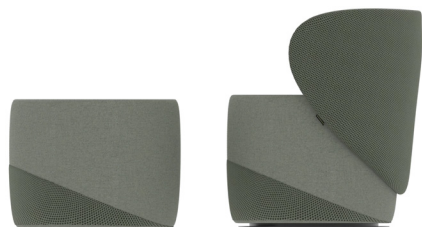

SILVER NEST



GRAPHITE NEST

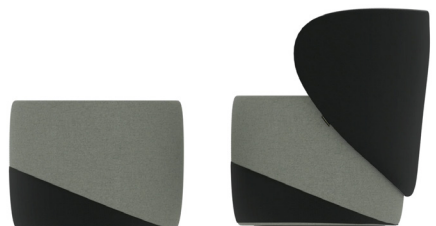

BLACK NEST



VIBE



ACOUSTIC ARMCHAIR



GET READY FOR SOME COLORFUL VIBES

Vibe is an acoustic, modern design chair; ideal for smart working, multi-function areas, meeting rooms, conference rooms, cafés, restaurants, hotel rooms and more!

Perfect for any interior where the reverberation of sound is an issue and comfort & style are a priority.



SOUND ABSORBANT



2 YEAR GUARANTEE



FIRE RESISTANT



ANTI-MICROBIAL



VERSATILE



EASY TO CLEAN





SET THE **MOOD.**

CHOOSE YOUR **VIBE.**

VIBE is the most dynamic chair within the acoustic seating collection.

Each VIBE Acoustic Armchair has a double upholstered seat and back for optimum comfort. Flexibility in the back design offers support, while also enhancing the sitting experience.

SOLID BEECH WOOD

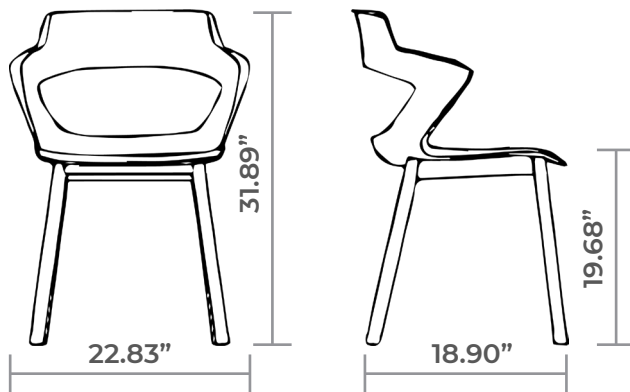

CHAIR DIMENSIONS

Width	22.83"
Depth	18.90"
Height	31.89"
Seat Height	19.68"
Arm Height	27.95"

CHAIR DIMENSIONS

Width	22.83"
Depth	20.47"
Height	31.89"
Seat Height	19.68"
Arm Height	27.95"

METAL PENCIL FRAME

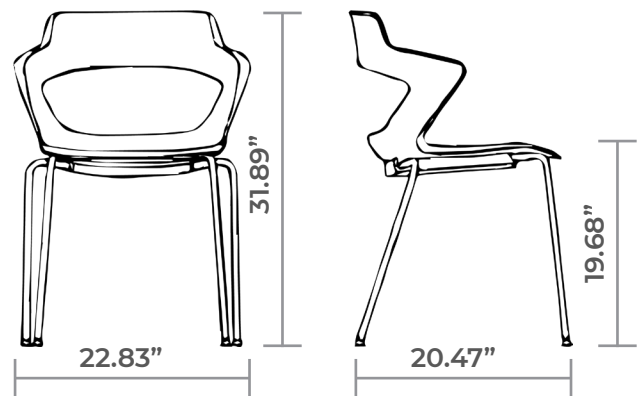

CHAIR DIMENSIONS

Width	22.83"
Depth	21.65"
Height	31.89"
Seat Height	19.68"
Arm Height	27.95"

METAL SLED FRAME

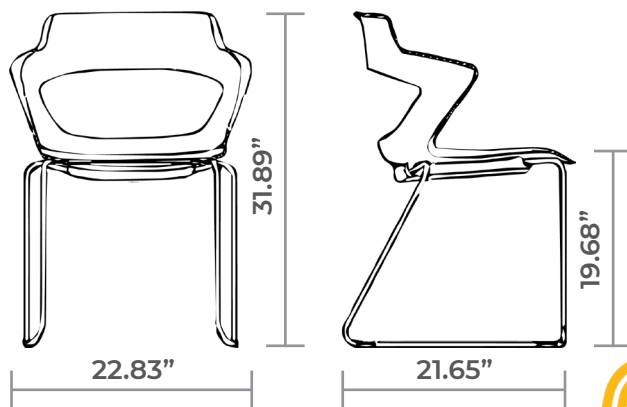

CHAIR DIMENSIONS

Width	22.83"
Depth	21.65"
Height	31.89"
Seat Height	19.68"
Arm Height	27.95"



VIBE

ACOUSTIC ARMCHAIR



CONFIDENCE IN TEXTILES
Tested for harmful substances
according to Oeko-Tex® Standard 100
1111052 Centexbel

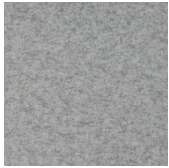

SOFTY FABRIC

*Standard for inner portion of armchair.



INNER CHAIR FABRIC

With two acoustic fabric options for the outer chair; *SPOCK* & *UNICOLOR WOOL*, and multiple options for leg style, you won't have any issues finding the look that suits your **VIBE!**



OUTER CHAIR FABRIC

CONFIDENCE IN TEXTILES
Tested for harmful substances
according to Oeko-Tex® Standard 100
1111052 Centexbel

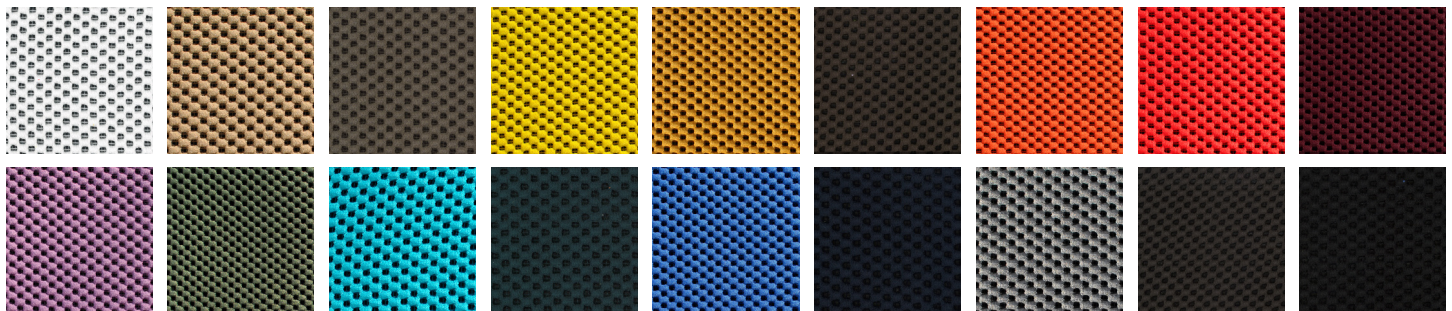

SPOCK FABRIC



VIBE

ACOUSTIC ARMCHAIR

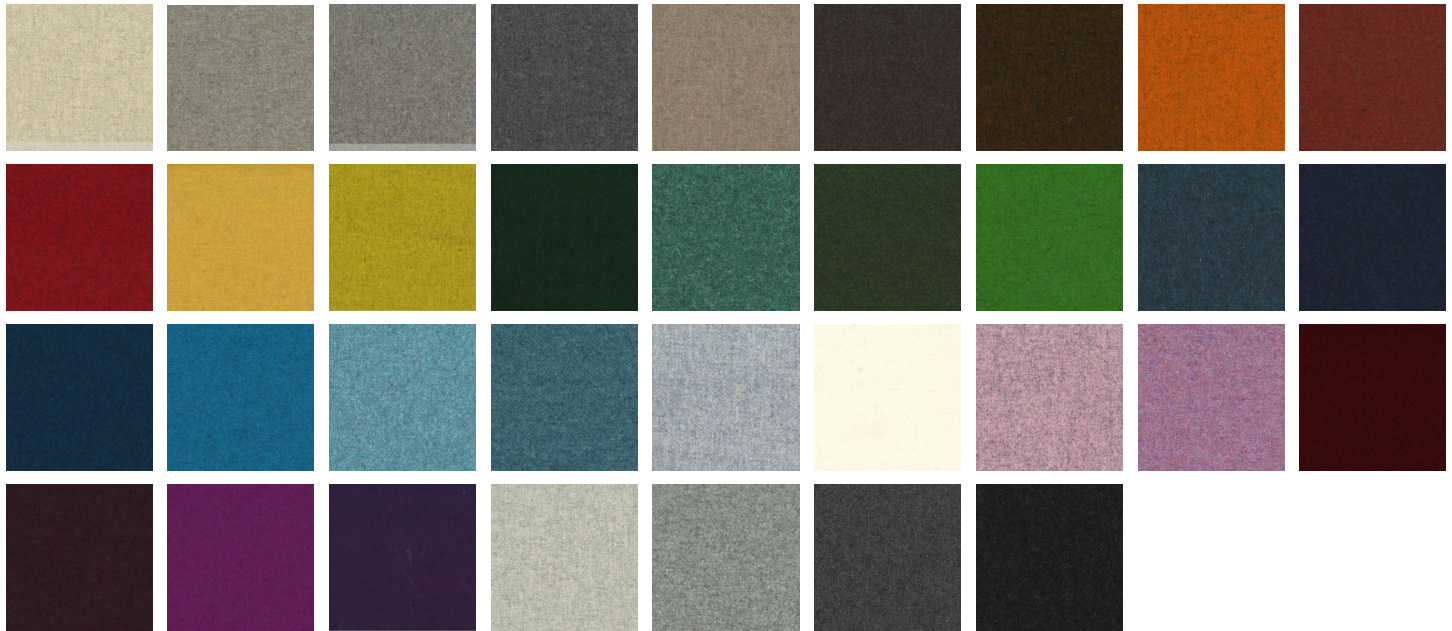

UNICOLOR WOOL FABRIC

Unicolor wool fabric ONLY available for VIBE with wood base.

VIBE Acoustic Armchair has three design options for its base: solid beech wood, metal pencil frame and metal sled frame. Each option is also available in multiple finishes.



BEECH WOOD

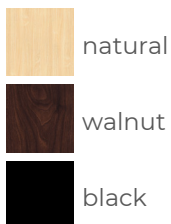

PENCIL FRAME

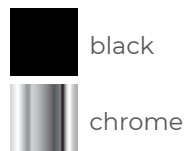

SLED FRAME

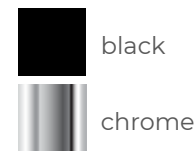

VIBE

ACOUSTIC ARMCHAIR



SNOW
VIBE



DUNE
VIBE



WOOD
VIBE



BUMBLEBEE
VIBE



HONEY
VIBE



COFFEE
VIBE



CORAL
ORANGE
VIBE



CANDY RED
VIBE



BOURDEAUX
VIBE



VIOLET
VIBE



TURQUOISE
VIBE



JUNIPER
VIBE



GREEN
RIVER
VIBE



ROYAL
VIBE



DENIM
VIBE



SILVER
VIBE



GRAPHITE
VIBE



BLACK
VIBE

*SPOCK OPTION AVAILABLE FOR ALL BASE TYPES.



VIBE

ACOUSTIC ARMCHAIR



*UNICOLOR WOOL ONLY AVAILABLE WITH WOOD BASE

